

Jesus took the children
into His arms.
What did He do next?

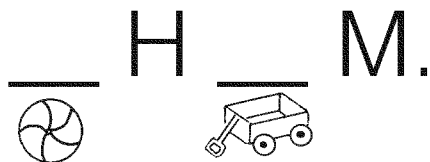

Use the code to fill in the missing letters.

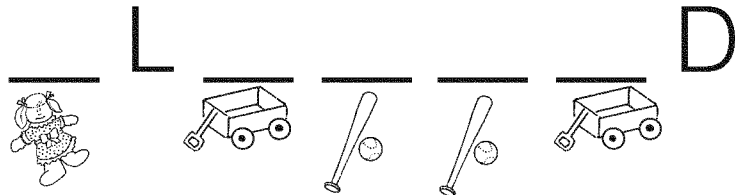
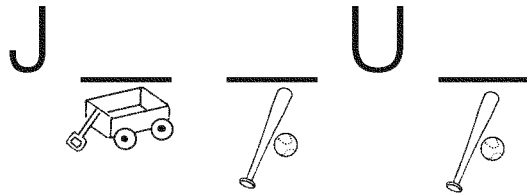

Ages 3+

Mark 10:2-16

Children Come to Jesus

People brought their little children
to Jesus.

Help the children reach Jesus.

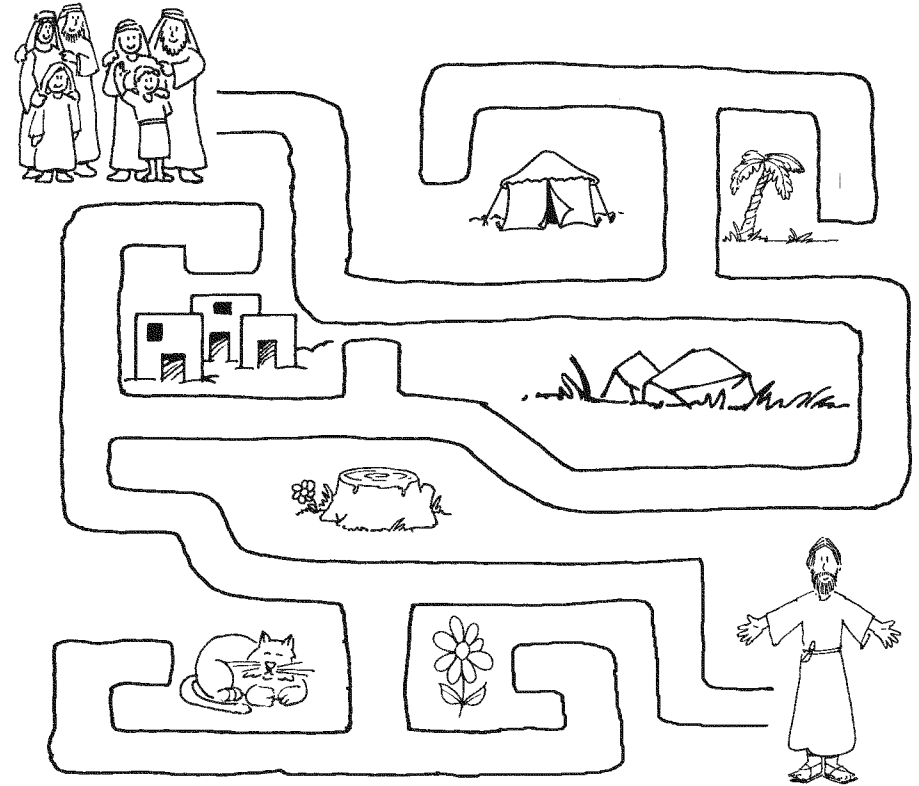

Westminster Presbyterian Church

Grand Rapids, MI

Enter your **SECRET CODE** to unlock games @
games.childrensbulletins.com

SECRET CODE
DHDDNO

The disciples tried to stop the people.

Circle 7 differences in the bottom picture.

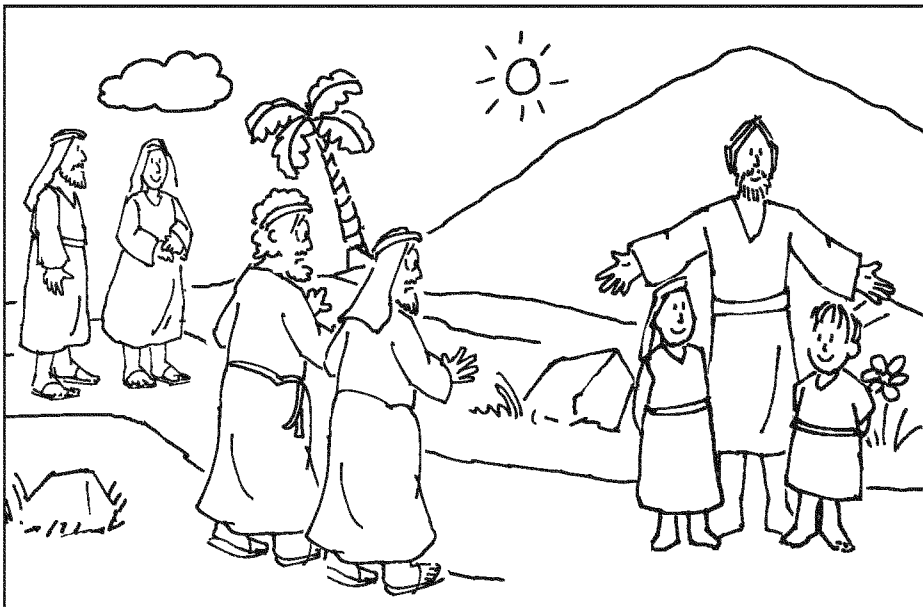

Jesus said, "Let them come."



Count the hidden hearts.
Trace the number below.



5 or 6 or 7 ?



What did Jesus do after He told them this?

Use the sign language code key to decipher the answer.

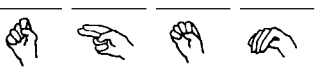
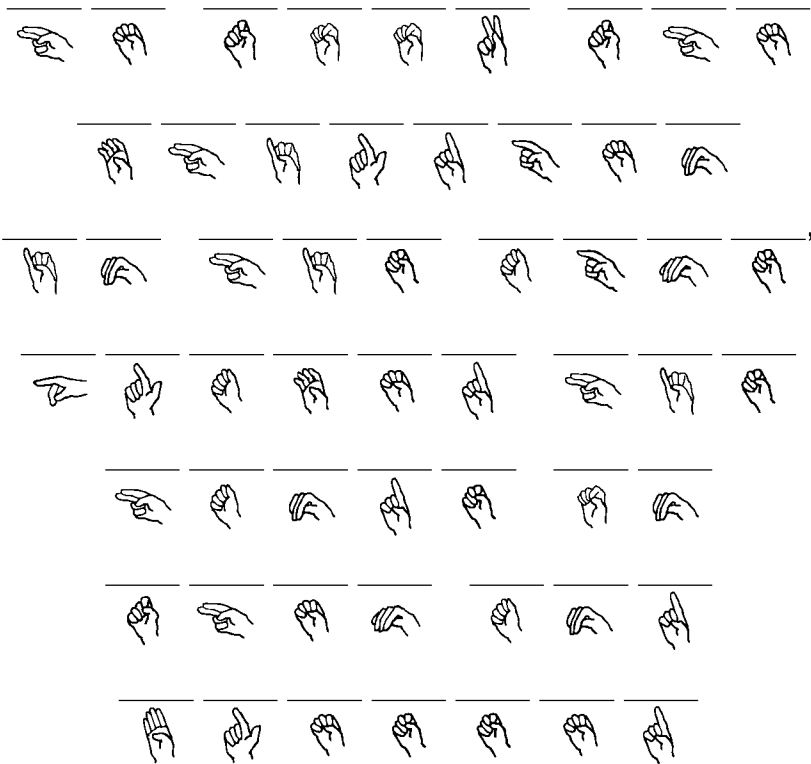
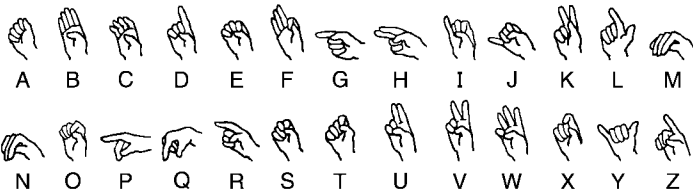

Ages 7+

Mark 10:2-16

Children and Jesus

People were bringing little children to Jesus for Him to bless. But what did Jesus' disciples do?



Follow the correct path through the maze to find the letters to fill in the blanks.

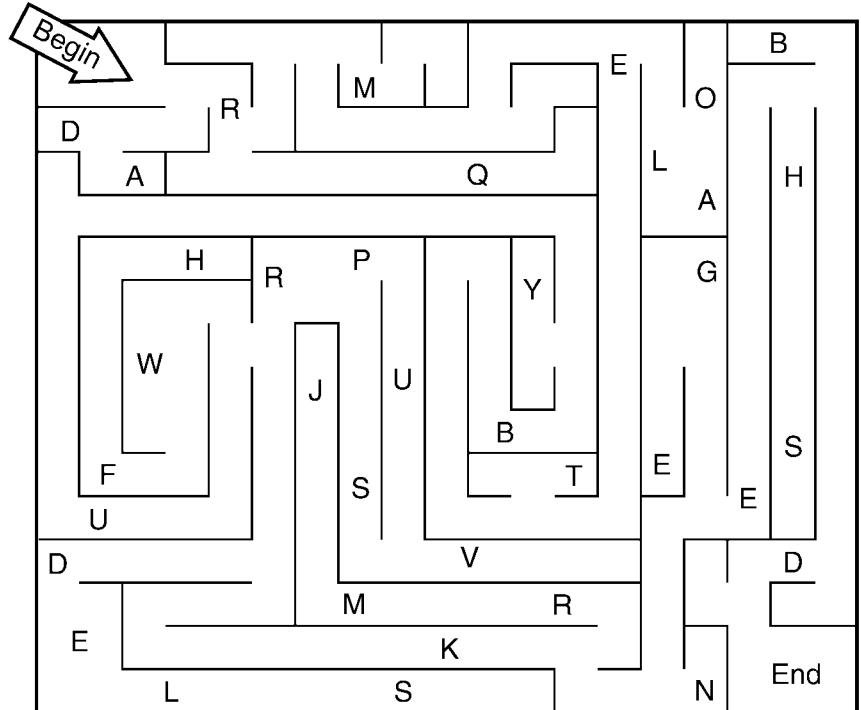

Jesus' disciples _____ them.

Westminster Presbyterian Church

Grand Rapids, MI

Enter your **SECRET CODE** to unlock games @ games.childrensbulletins.com

SECRET CODE
MNEDB2

How did Jesus react to this?

Fill in the word for each picture shown.
Then use the letters in the boxes to fill in the answer below.

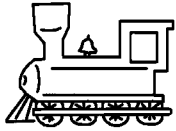

____ _



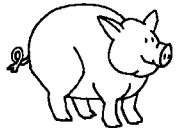

____ _

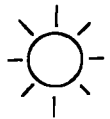

____ _

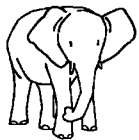

____ _

Jesus was

_____.*

*This word means "angry."



What did Jesus say to His disciples?

Unscramble the letters to fill in the blanks.



"Let the 1) _____

2) _____ come to Me,
and do not 3) _____ 4) _____,
for the 5) _____ of 6) _____
7) _____ to 8) _____
as 9) _____."